



**WORLD'S BEST
ALLOY BULLBARS**

East Coast Bullbars (ECB Pty Ltd)

Tel: 07 3897 5700

Fax: 07 3283 1168

ecb@ecb.com.au www.ecb.com.au

29 Snook St
Clontarf QLD 4019
Australia

Po Box 122
Margate QLD 4019
Australia

EAM156SY

REPLACES: 16.01.18

REVISED: 13.08.22

FITTING INSTRUCTIONS MITSUBISHI TRITON MQ MY16 5-2015 ON BIG TUBE PROTECTION BAR WITH FOG LIGHTS VEHICLE FRONTAL PROTECTION SYSTEM (VFPS) FOR AIR BAG & ADR COMPLIANT VEHICLES

Check installation hardware before commencing.

1. Open bonnet.
2. Remove steel under body guard. Completely remove two 12mm head bolts at front, loosen only two 12mm head bolts at rear and remove from vehicle.
3. Remove twelve plastic screw clips from top panel and remove plastic panel. **See figure 1.**
4. Remove one black plastic push pull clip from top of grille beside headlight per side. Pulling gently forward on lower grille to release clips from bumper and remove grille from vehicle.
5. Remove three 10mm head bolts from top of bumper between headlights. Remove three 10mm head screws from front wheel arch flare, one push/pull clip from underside of flare, gently pull outwards on flare while applying pressure to clip on inside to remove flare. Remove six push/pull clips from wheel arch liner and remove per side. Unplug fog light if required. Pull rear wing of bumper out to unclip from guard and under headlight and remove bumper.
6. Remove the air dams from side of intercooler, mark and trim off 45mm so steel mount will not rub on air dam. **See figure 2.**
7. Remove vertical bumper stay, two 10mm head nuts (per side). **See figure 3.**
8. Remove six 14 mm head bolts from front cross member and remove bumper reinforcement.
9. Place 3/8 x 4 inch bolt, flat washer and 58 mm tube spacer (supplied) into chassis rail per side as shown in **figure 4.**
10. Fit ECB steel mounting brackets over cross member to outside of chassis rail using bolts supplied. One M10 x 1.25 x 40 bolt, spring washers, flat washer (supplied) in front hole of chassis rail into captive nut. One M10 x 40 bolt, flat washers, spring washer and nut (supplied) in rear hole. Flat washer spring washers and nut onto 3/8 x 4 inch (supplied) on bolt in rail. (leave bolts loose till gusset is fitted)
11. Fit ECB steel mounting gussets onto inside of mount to front cross member using bolts supplied. Two M10 x 1.25 x 40 bolts, flat washer, spring washers into captive nuts (supplied) and two M10 x 40 bolt flat washer, spring washer and nut and washer on wire (supplied) into inside hole. Two 10 mm x 30 round spacers (supplied) per side. Four M10 x 1.25 x 40 bolt, flat washer, spring washer and nuts (supplied). Once all bolts are fitted align mount to front of vehicle and tighten all bolts. **See figure 5.**
12. Refit air dam into position using original equipment.



**WORLD'S BEST
ALLOY BULLBARS**

East Coast Bullbars (ECB Pty Ltd)

Tel: 07 3897 5700

Fax: 07 3283 1168

ecb@ecb.com.au www.ecb.com.au

29 Snook St
Clontarf QLD 4019
Australia

Po Box 122
Margate QLD 4019
Australia

13. Disconnect indicator and parking lights on vehicle. Install ECB quick click wiring harnesses (supplied) between disconnected harness and indicator / park lights on vehicle. Run wiring out from under lights ensuring clearance from sharp edges and moving parts.
14. Check template for correct sizing and carefully cut out. On flared vehicle, remove bumper flare from bumper. Using ECB bumper cut template (supplied), mark out bumper for cutting. Use masking tape to avoid damaging paint work when cutting bumper. Refit flare to bumper. Mark and trim flair to suit bumper cut if required. Trim cut line with 3mm clip lock supplied. **See figure 6 and 7.**
15. Refit bumper to vehicle using original equipment in the reverse step of 4.
16. Fit ECB LED indicator / park lights into protection bar as per instructions supplied with the LED indicator kit. **NOTE: Ensure park light is to outside. See figure 8.**
17. Attach ECB fog light bracket only to protection bar. Place M6 x 20 bolts, spring washers (supplied) through light mount from inside and attach nut to top. Slide assembly into light mount in Protection bar and centralize light to hole. **TIGHTEN FIRM ONLY. See figure 9.**
18. Attach 6mm clip lock trim (supplied) to top of ECB protection bar. **NOTE:** Trim off lower edge on an angle so trim will sit flush with end of protection bar. **See figures 10, 11 and 12.**
19. Fit ECB protection bar to outside of steel mount using bolts supplied. Three M12 x 40 bolts, flat washers, spring washers and nuts (supplied) per side. Align protection bar to front of vehicle and tighten all bolts. **See figures 13 and 14.**
20. Fit fog light onto bracket in protection bar and firmly tighten. Connect ECB Quick Click fog light wiring harness (supplied) into original wiring harness.
21. Fit ECB under body guards using bolts supplied five M6 x 30 bolts flat washers and nyloc nuts per side. **Do not tighten bolts until all bolts are fitted.**
22. Refit plastic guard liner and mark and trim of excess liner, secure to under body guard with self tapers supplied. When trimming liner trim of humps at lower edge so liner fits flush. **CAUTION** Ensure placement of screws (supplied) on passengers side is away for washer bottle. Screws placed too high could create a rubbing issue on the bottle. **See figure 15 and 16.**
23. Refit steel under body guard using original equipment in the reverse step of 1.

ENSURE NUMBER PLATE IS CLEARLY VISABLE

Note: When fitting/refitting the licence plate to the vehicle, ensure there is no obstruction to licence plate vision in accordance with local authorities. If required relocate licence plate to an alternate location.

Further VFPS Notes:

- a) Do not attach VFPS to the vehicle using anchorages not intended for this purpose (e.g. engine mounting bolts).
- b) Do not use this product for any vehicle make or model, other than those specified by the VFPS manufacturer.
- c) Do not remove the plaque or label from the VFPS.
- d) Do not modify the structure of the VFPS in any way.
- e) No accessory or fitment should project forward of the VFPS forward profile.
- f) **ENSURE THESE INSTRUCTIONS ARE LEFT WITH VEHICLE OWNER AND/OR OPERATOR.**



East Coast Bullbars (ECB Pty Ltd)

Tel: 07 3897 5700

Fax: 07 3283 1168

ecb@ecb.com.au www.ecb.com.au

WORLD'S BEST
ALLOY BULLBARS

29 Snook St
Clontarf QLD 4019
Australia

Po Box 122
Margate QLD 4019
Australia

IMPORTANT INFORMATION

Periodically check bolts and nuts for correct tightness, especially if travelling on rough roads

FITTING KIT

1 – Pair Steel mounting brackets	2 – M6 x 20mm bolts
1 – Pair Steel mounting gussets	10 – M6 x 30mm bolts
4 – M10 x 30 steel round spacer washers	20 - M6flat washers
2 – 10 NB tube spacer 58 mm long	2 – M6 spring washers
1 – Pair Under body guards	2 – M6 nuts
6 – M12 x 1.75 x 40mm bolts	10 – M6 nyloc nuts
12 – M12 flat washers	4 – 8 gauge 18-25 button head self tapping screws
6 – M12 spring washers	1 – ECB LED Indicator / Park light kit
6 – M12 x 1.75 nuts	1 – ECB Quick Click Harness kit (IC15MITRIHINDH)
2 – 3/8 x 4 inch bolts	1 – Fog light kit
2 – 3/8 nuts	4 – Fog light surrounds
12 – M10 x 1.25 x 40mm bolts	2 – Fog light quick clip harness (IC10D40S1004ECBH)
24 – M10 flat washers	1 – 2500 length 6mm clip lock trim
14 – M10 spring washers	2 – 400 length 3mm clip lock trim
6 – M10 x 1.25 nuts	2 – 300 length 3mm clip lock trim
2 – M10 nut and washer on 300mm wire	

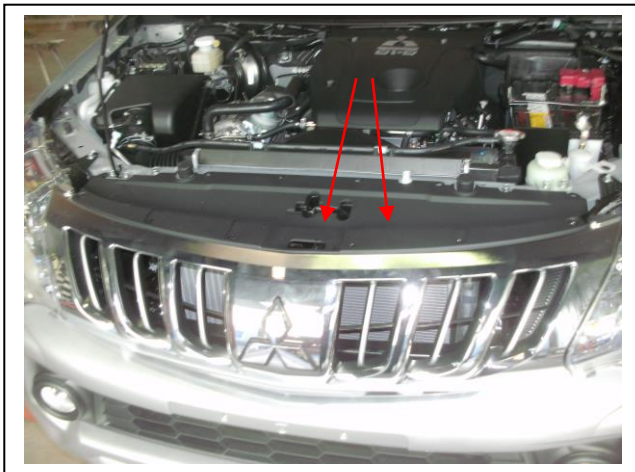


Figure 1

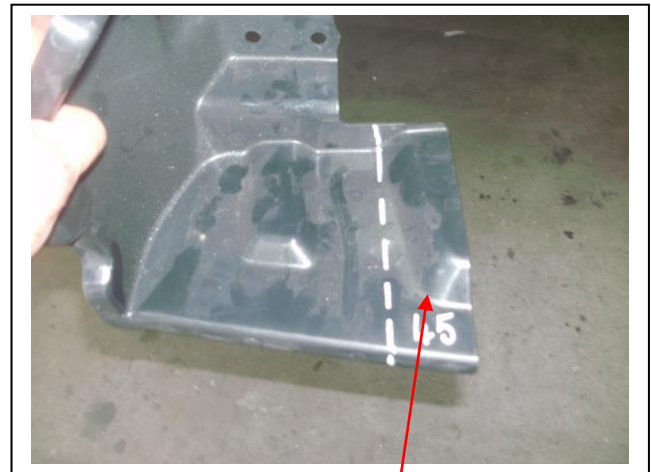


Figure 2

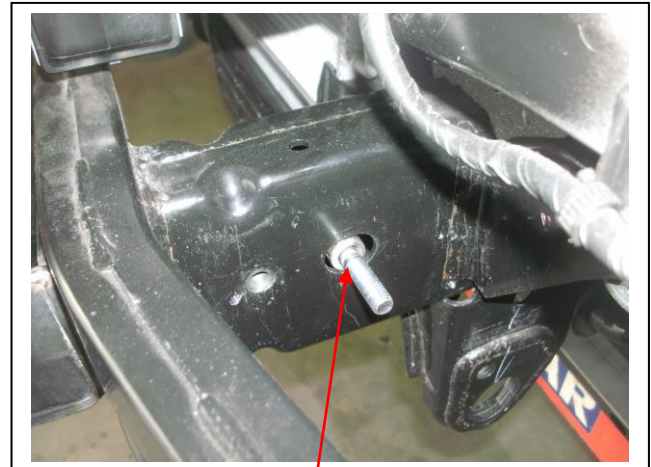


Figure 4



East Coast Bullbars (ECB Pty Ltd)

Tel: 07 3897 5700

Fax: 07 3283 1168

ecb@ecb.com.au www.ecb.com.au

29 Snook St
Clontarf QLD 4019
Australia

Po Box 122
Margate QLD 4019
Australia

WORLD'S BEST
ALLOY BULLBARS

Figure 3



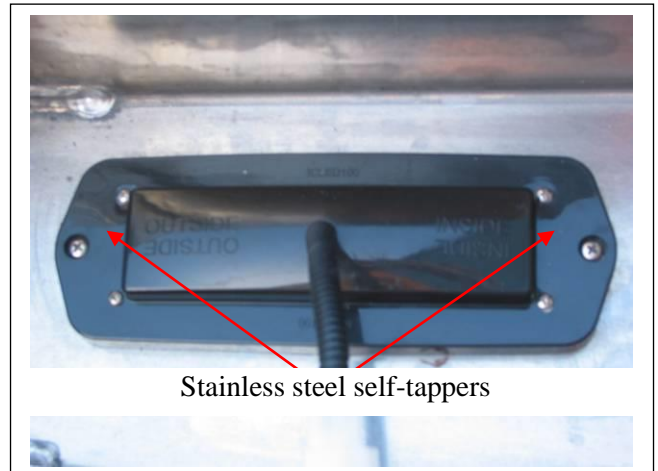
Figure 5



Figure 6 : Non flair vehicle

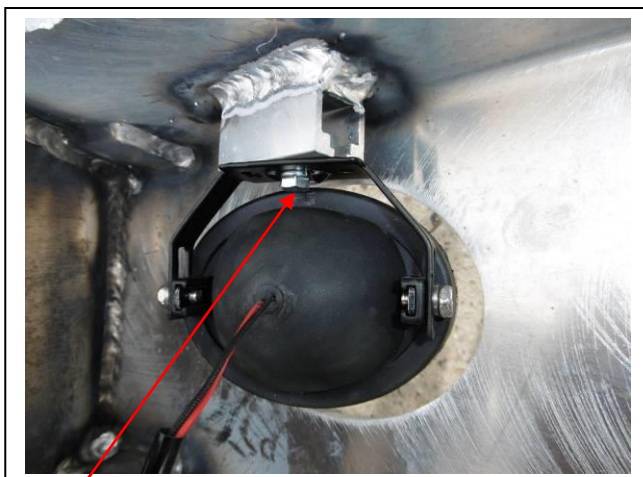


Figure 7 : Flared vehicle



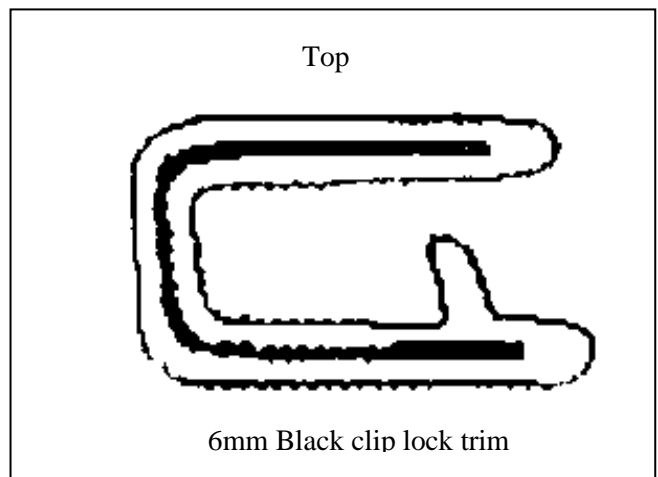
Stainless steel self-tappers

Figure 8.



M6 bolt

Figure 9



6mm Black clip lock trim

Figure 10.



WORLD'S BEST
ALLOY BULLBARS

East Coast Bullbars (ECB Pty Ltd)

Tel: 07 3897 5700

Fax: 07 3283 1168

ecb@ecb.com.au www.ecb.com.au

29 Snook St
Clontarf QLD 4019
Australia

Po Box 122
Margate QLD 4019
Australia

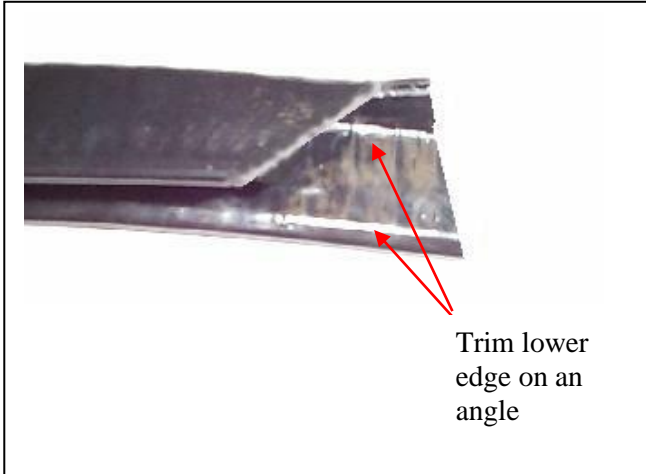


Figure 11.

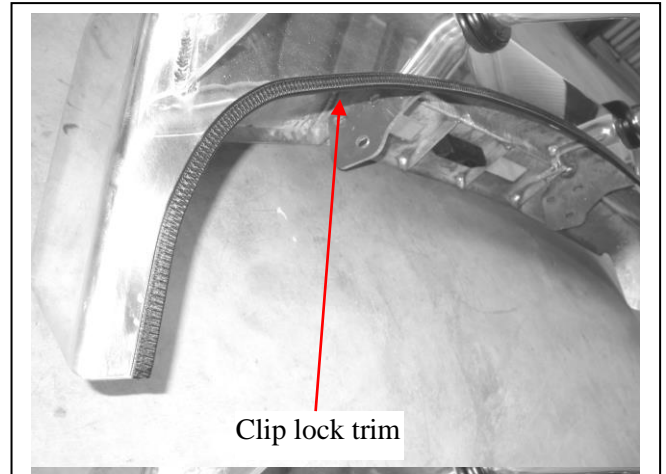


Figure 12.



Figure 13



Figure 14

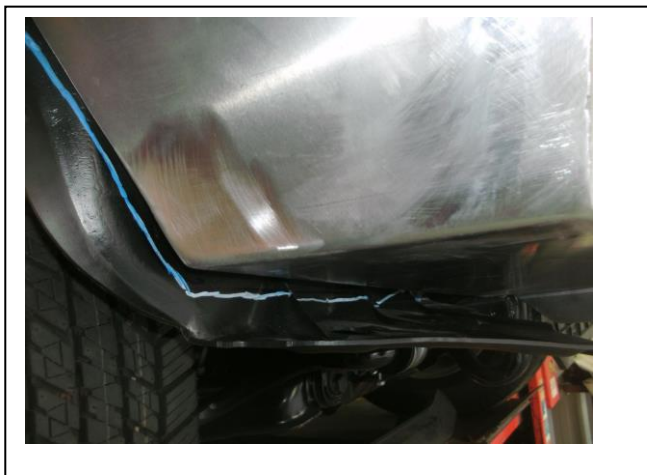


Figure 15: Marking liner to trim



Figure 16: Liner looks like this after trimming



**WORLD'S BEST
ALLOY BULLBARS**

East Coast Bullbars (ECB Pty Ltd)

Tel: 07 3897 5700

Fax: 07 3283 1168

ecb@ecb.com.au www.ecb.com.au

29 Snook St
Clontarf QLD 4019
Australia

Po Box 122
Margate QLD 4019
Australia



**WORLD'S BEST
ALLOY BULLBARS**

East Coast Bullbars (ECB Pty Ltd)

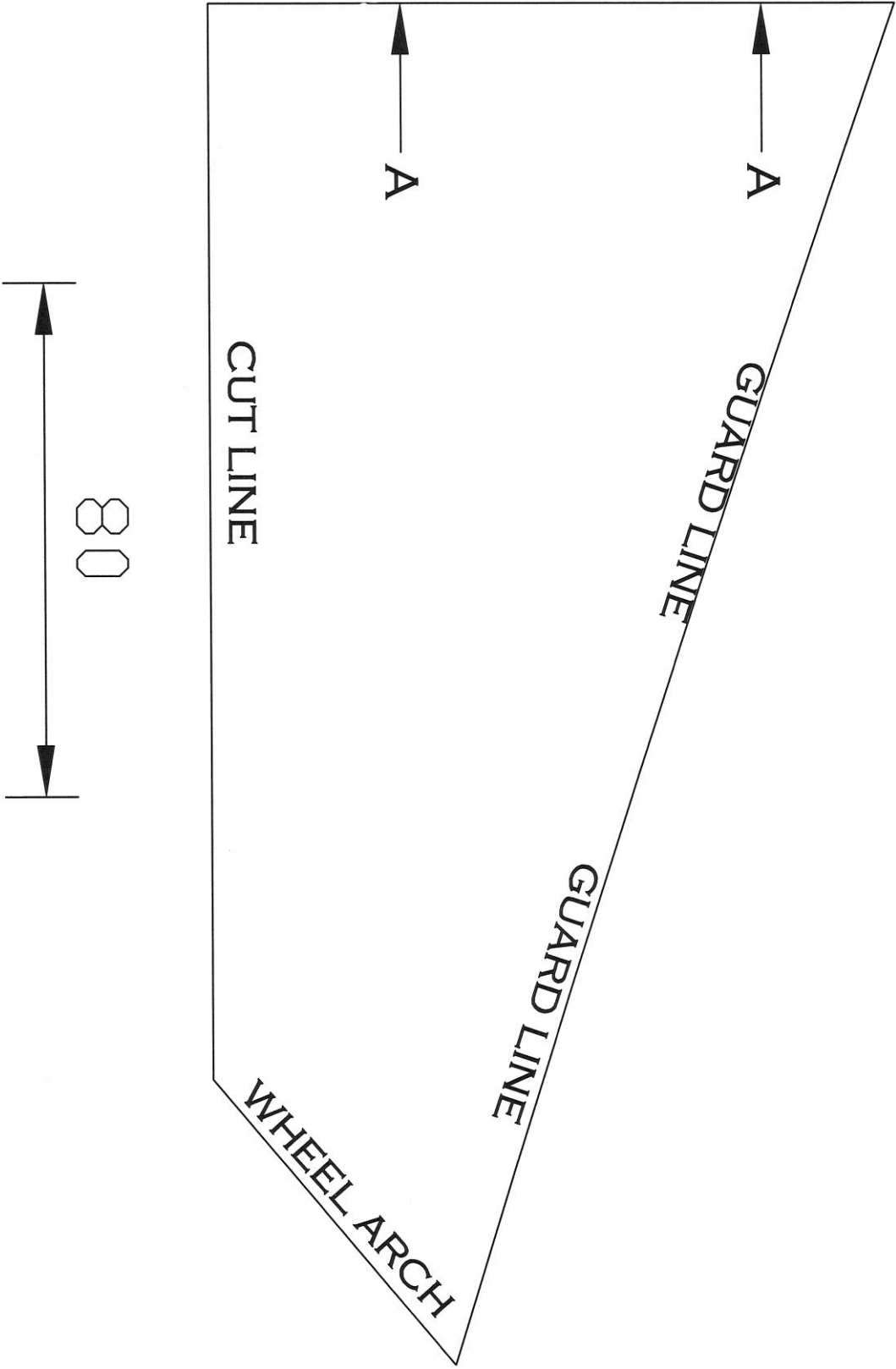
Tel: 07 3897 5700

Fax: 07 3283 1168

ecb@ecb.com.au www.ecb.com.au

29 Snook St
Clontarf QLD 4019
Australia

Po Box 122
Margate QLD 4019
Australia





**WORLD'S BEST
ALLOY BULLBARS**

East Coast Bullbars (ECB Pty Ltd)

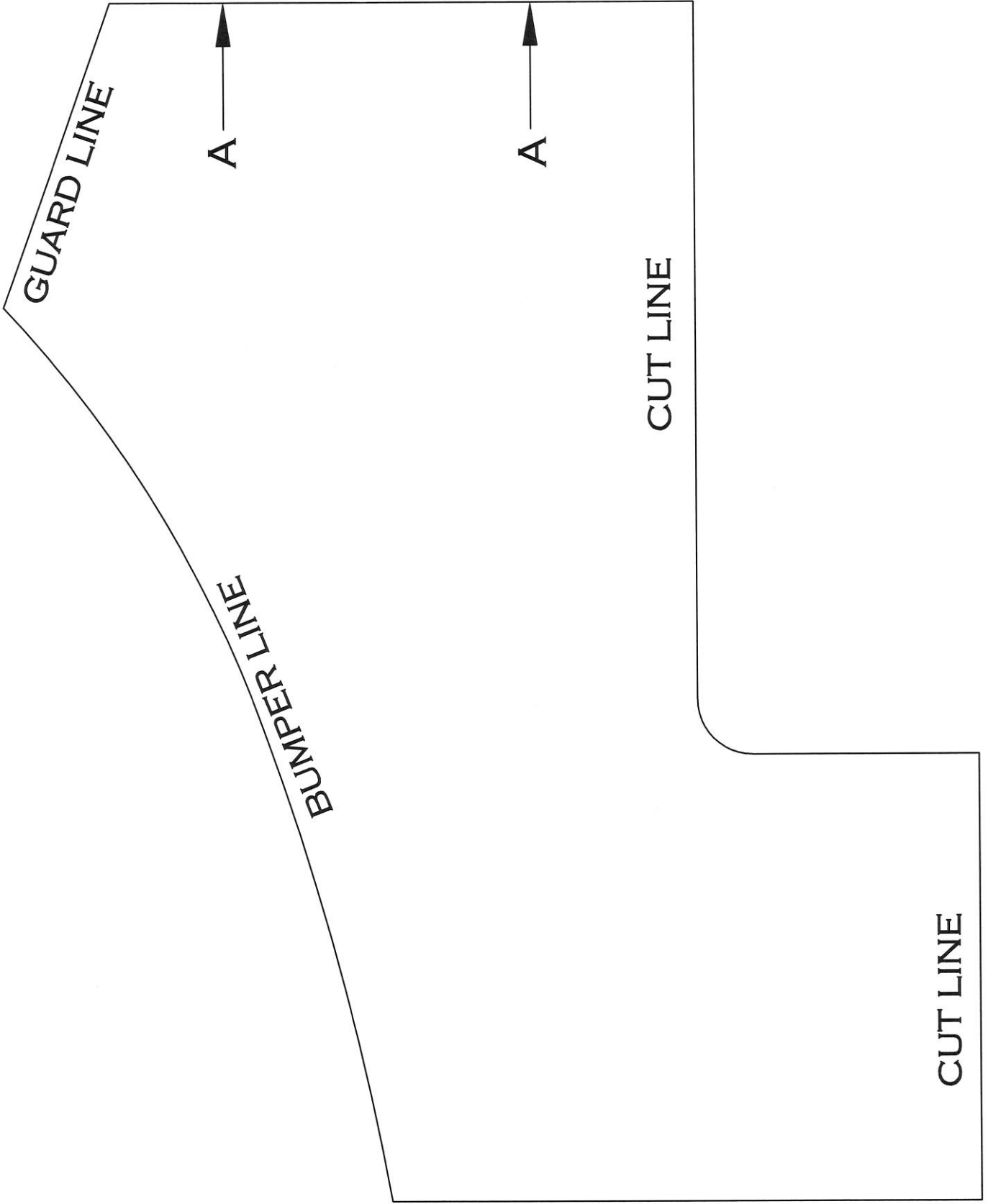
Tel: 07 3897 5700

Fax: 07 3283 1168

ecb@ecb.com.au www.ecb.com.au

29 Snook St
Clontarf QLD 4019
Australia

Po Box 122
Margate QLD 4019
Australia





**WORLD'S BEST
ALLOY BULLBARS**

East Coast Bullbars (ECB Pty Ltd)

Tel: 07 3897 5700

Fax: 07 3283 1168

ecb@ecb.com.au www.ecb.com.au

29 Snook St
Clontarf QLD 4019
Australia

Po Box 122
Margate QLD 4019
Australia



**WORLD'S BEST
ALLOY BULLBARS**

East Coast Bullbars (ECB Pty Ltd)

Tel: 07 3897 5700

Fax: 07 3283 1168

ecb@ecb.com.au www.ecb.com.au

29 Snook St
Clontarf QLD 4019
Australia

Po Box 122
Margate QLD 4019
Australia

We value your comments

Dear Fitter,

ECB would like to know how you went with the installation of this product. We value your comment and may need to contact you to clarify some details so please complete your contact details clearly.

We would appreciate if you could complete as many of the following details as possible.

Your Name:	Your contact No.
Product Part No.	Product Invoice No.
Product Description:	Make, model, and year of vehicle:
Product Work Order No.	Company your from/Company product purchased from:

Date of Fitment: ____/____/____

Was the fitting hardware supplied complete?

Yes

No

If no what was not supplied

Did the installation go well?

Yes

No

Please provide comments

Please draw diagrams if you need to.

Post to
Reply Paid 122
PO Box 122
Margate QLD 4019

Fax to
(07) 3283 1168



**WORLD'S BEST
ALLOY BULLBARS**

East Coast Bullbars (ECB Pty Ltd)

Tel: 07 3897 5700

Fax: 07 3283 1168

ecb@ecb.com.au www.ecb.com.au

29 Snook St
Clontarf QLD 4019
Australia

Po Box 122
Margate QLD 4019
Australia



WORLD'S BEST
ALLOY BULLBARS

East Coast Bullbars (ECB Pty Ltd)

Tel: 07 3897 5700

Fax: 07 3283 1168

ecb@ecb.com.au www.ecb.com.au

29 Snook St
Clontarf QLD 4019
Australia

Po Box 122
Margate QLD 4019
Australia

DESPATCH CHECKLIST EAM156SY

Work Order #		See other side of this page for photos of all mounts
Finish:		
Transport:		
Due Date:		

- OC.....1 – Pair Steel mounting brackets.
- OC.....1 – Pair Steel mounting gussets
- OC.....1 – Pair Under body guards
- BK.....1 – Bolt Kit.
- BK.....1 – LED ECB indicator / park light kit.
- BK.....1 – ECB quick click wiring harness (IC15MITRIHINDH)
- BK.....1 – ECB Fog light Kit (55 WATT)
- BK.....1 – Quick click harness (IC05D40S1004ECBH)
- BK.....1 – 2500 mm length 6mm clip lock trim
- BK.....2 – 400 mm lengths 3 mm clip lock trim
- BK.....2 – 300 mm lengths 3mm clip lock trim
- OC.....2 – ECB Overrides – **Fitted to Bar**
- OC.....2 – 6mm Air Vents – **Fitted to Bar**
- OC.....4 – 6mm Air Vents – **Fitted to Bar**

_____/_____
Wrapper's initials / Checker initials



Is this product “the best it can be” Yes
If **NO** fix before continuing

All parts checked and completed by:

Nut and bolts: _____ Date ___/___/___

Order control: _____ Date ___/___/___

Final wrap check: _____ Date ___/___/___



WORLD'S BEST
ALLOY BULLBARS

East Coast Bullbars (ECB Pty Ltd)

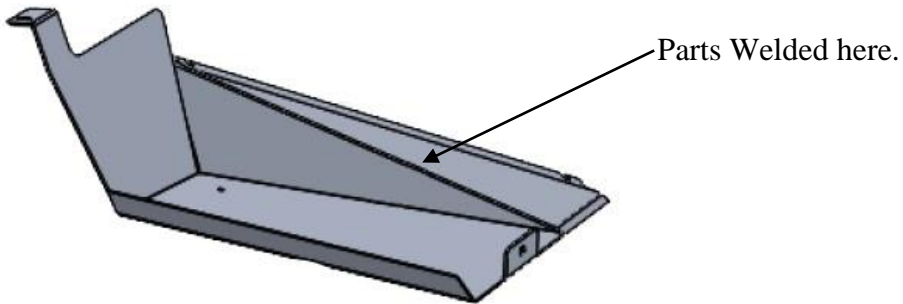
Tel: 07 3897 5700

Fax: 07 3283 1168

ecb@ecb.com.au www.ecb.com.au

29 Snook St
Clontarf QLD 4019
Australia

Po Box 122
Margate QLD 4019
Australia



Wrapper's initials / Checker initials

L/H side underbelly
R/S is direct mirror of part shown